

QUELL / USER GUIDE

Quell Battery Operated Carbon Monoxide Alarm



Part Number: 130415

Model: PD04

Quell® is a registered trademark of Chubb Fire & Security Pty Ltd
Copyright © 2012 Chubb Fire & Security Pty Ltd. All rights reserved.



EN50291-1 : 2010
EN50291-2 : 2010
License No. KM98848

Contents

1. What is Carbon Monoxide (CO)?
2. Important Safety Information
3. Switching on Your CO Alarm
4. Installation Instructions – Recommended Locations
5. Installation Instructions – Mounting
6. Using your CO Alarm
Warning Signals, Testing / Re-setting, LCD read-outs , Peak Level Display
7. Replacement Batteries / End-of-Life
8. **What To Do If Your Alarm Sounds**
9. Maintenance of your Alarm
10. Troubleshooting
11. Product Specifications
12. Warnings and Important Notices
13. Warranty Information
14. Environmental Protection

Product Features and Specifications

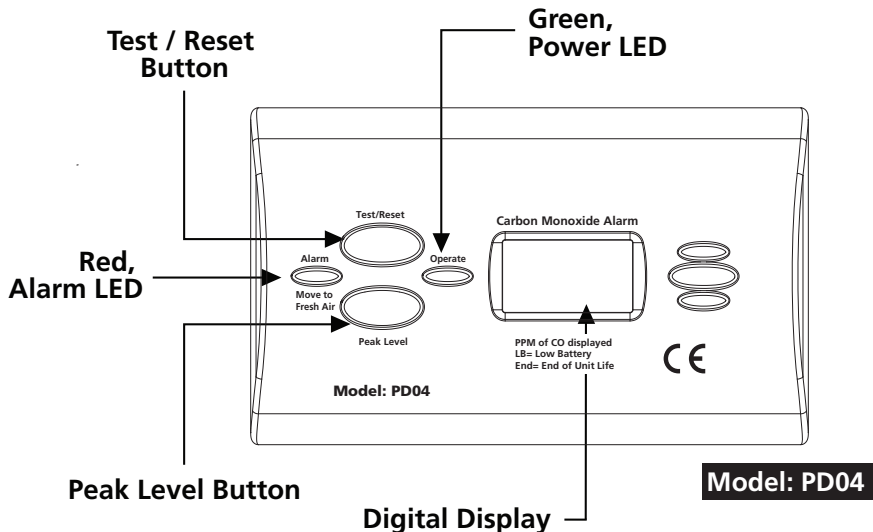

1. What is Carbon Monoxide?

Carbon monoxide (CO) is a highly poisonous gas with no taste, colour or smell.

Potential Sources of CO

- Wood-burning stoves
- Gas boilers and fires
- Gas stoves
- Oil and coal burning appliances
- Portable gas heaters
- Blocked flues and chimneys
- Fumes from integral garages
- Barbecues

THIS CO ALARM IS NOT A SUBSTITUTE FOR THE CORRECT MAINTENANCE OF YOUR APPLIANCES.

Carbon monoxide can be produced from poorly burning appliances or from blocked flues and chimneys.

If your alarm has sounded and you have ventilated the room the CO may have dispersed before help arrives. It is crucial that the source of CO is determined and appropriate maintenance carried out.

Carbon monoxide is a cumulative poison. Longterm exposure to low levels may cause symptoms. This Quell alarm is time-weighted – the higher the level of CO, the sooner it will alarm.

2. Further information for Caravan and Boat Owners

The following can lead to carbon monoxide being produced:

- Using LPG cooking appliances for space heating
- Leaving LPG appliances on overnight
- Barbecues within the boat cabin or near a caravan door (e.g. under an awning)

To be safe, know the possible sources of CO in your home. Keep fuel burning appliances, chimneys and vents in good working condition. Learn the early symptoms of exposure, and if you suspect CO poisoning, move outside into fresh air and get emergency help. Your first line of defence is an annual inspection and regular maintenance of your appliances. Contact a licensed contractor or call your local utility company for assistance.

2. Alarm levels as defined by European Norm EN50291-2010*

The table below shows the response times at which your CO alarm will sound:

Parts per Million (PPM) of CO	Time until Alarm
50	60 – 90 minutes
100	10 – 40 minutes
300	Must alarm in less than 3 minutes

CO Advice and Information

The table below shows the physiological effects of exposure to increasing concentrations of CO:

Parts per Million (PPM)	Effects on Adults
100	Slight headache, nausea, fatigue (flu-like symptoms)
200	Dizziness and headache within 2 – 3 hours
400	Nausea, frontal headache, drowsiness, confusion and rapid heart rate. Risk to life after over 3 hours of exposure
800	Severe headaches, convulsions, vital organ failures. Death possible within 2 – 3 hours

* EN50291-2010 is a European Standard for "Electrical apparatus for the detection of carbon monoxide in domestic premises - Part 1: Test methods and performance requirements"

2. Important Safety Information

If you recognise any of the above symptoms consult your Doctor immediately.

Young children, the elderly as well as pets are more susceptible to the dangers of CO.

Your Quell CO alarm is designed to detect CO gas. It is not designed to detect smoke, fire or other gas such as natural gas.

Ideal for use in domestic premises such as bedrooms, living areas, and caravans, motor homes and boats.

The advice and information on page 5 are intended as a general guide only. Sensitivity and symptoms may vary with the individual depending for instance on age, medical history and pre-existing medical conditions. Individuals with certain specific medical conditions may require an alarm that operates at lower levels of concentration. You should consult a qualified medical practitioner for further guidance.

IMPORTANT: Ensure that all family members are familiar with the symptoms of CO poisoning and how your alarm works.

3. Switching on Your CO Alarm

NOTE: Your CO alarm must be installed by a competent person using the guidance that follows:

1. Remove the batteries from the pack and insert them into the battery compartment. Make sure that you fit the batteries correctly to the polarity markings (+ or -) shown within the battery compartment. If correctly installed, the alarm will give a short beep.
2. To test the alarm, press the test button. The alarm will sound fully for 10 seconds. This confirms that the alarm is powered up and working.
3. The LCD screen will show “---” and then “888” before settling at “0”
4. Check that the green LED flashes at 30 second intervals to show that the alarm has power. This is easiest to see in a dark area, or with lights switched off.

4. Installation Instructions – Recommended Locations

Recommended Locations	Not Recommended
Place the alarm at least 2 metres from fuel burning appliances, and not more than 4 metres away	Do not place closer than 2 metres from fuel burning appliances
Away from draughts, such as doors and windows	Do not wall-mount close to obstructions (e.g. behind curtains, shelving or furniture)
Within hearing distance of bedrooms* If heating appliance is in the bedroom place the alarm at sleeping height	Do not fit in dusty, dirty or greasy areas (e.g. garages or workshops)
If wall-mounting, install at eye-level (approx 1.5m), and at least 30cm from adjoining walls or ceiling	Do not wall-mount within 30cm of the ceiling as this is a “dead air” space
If free-standing, the unit should be placed no more than 1 metre from the ground (to avoid permanent damage in case accidentally knocked)	Avoid areas subject to high humidity (e.g., bathrooms), cold (< 0°C) or hot (>40°C) areas and away from sinks

*It is recommended that at least one Quell carbon monoxide alarm is installed on each level of the home.

4. Installation Instructions – Recommended Locations

Map showing the recommended locations for your Quell carbon monoxide alarms, smoke alarms and fire extinguishers and fire blankets.

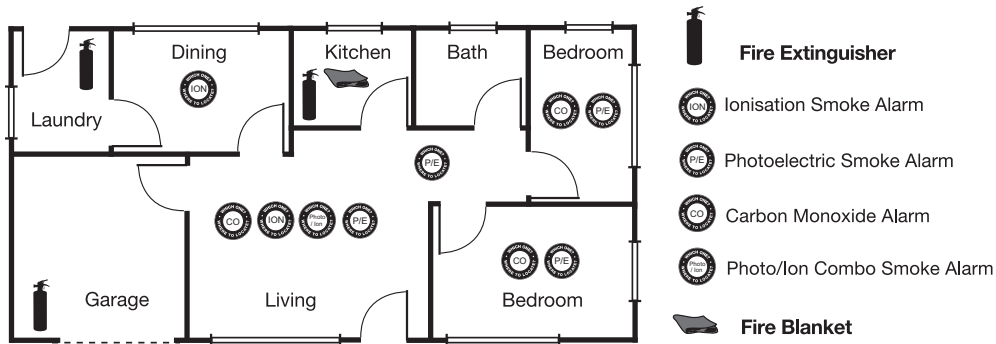

5. Installation Instructions – Mounting

THIS ALARM MUST BE INSTALLED BY A COMPETENT PERSON AND IS TO BE INSTALLED ACCORDING TO THESE INSTRUCTIONS

Wall-mounting

1. Drill two holes (5mm in diameter x 25mm deep) in a wall 7cm apart (you may wish to use the back-plate for guidance)
2. Insert the two rawl-plugs, that are supplied, into the holes
3. Insert the two screws as supplied into the holes ensuring enough of the screw sticks out of the wall (approx. 0.3cm)
4. Hook the alarm over the screws

Free-standing

1. No more than 1 metre from the floor (to minimise this risk of the alarm being permanently damaged should it be knocked to the floor from a greater height)
2. Make sure the alarm is in the upright position and not lying flat on the surface

5. Installation Instructions for Caravans and Boats

As well as being recommended for use in homes, this alarm is suitable for use in caravans, motor homes and boats.

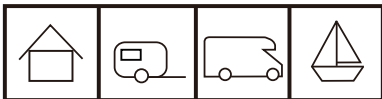

- Do not install directly above a source of heat or steam.
- Avoid locating close to vehicle and engine exhaust fumes as these can damage the alarm sensor







Additional instructions for boats:

To prevent developing high concentrations of CO avoid running the engine when:

- moored alongside objects such as a wharf, wall or another boat
- docked in a crowded marina

6. Using Your Alarm

Additional features for the CO alarm with the digital display screen, model PD04;

Digital Screen	LED	Sound emitted	What this means	Required action
	Green flash every 30 seconds	None	Normal operation. (LCD will not show levels < 30ppm)	None
	Red LED flashes	Full alarm	Dangerous levels of CO has been detected	Follow emergency procedures (see Page 16)
	Red LED flashes	Full alarm for 10 seconds	Successful test or reset sequence in operation	None - this is part of the standard test or reset procedure
	Red LED flashes every 60 seconds	Chirp every 60 seconds	Low batteries (Lb)	Change batteries
	Red LED flashes	Chirp every 30 seconds	Fault	Replace the alarm
	Red LED on	Constant tone	Malfunction	Replace the alarm
	Red LED flashes twice	Chirps twice every 30 seconds	End of Life	Replace the alarm

6. Using Your Alarm

Peak Level Display

Press and hold peak level button to display the most recent CO reading between 11 - 999ppm.

This feature is useful to help you to know what levels of CO may have been detected in your absence so corrective action can be taken (such as servicing your boiler).

NOTE: The peak level memory is cleared to zero if the test and peak level buttons are pressed at the same time, or by removal of the batteries.

CO levels up to 30ppm can occur under normal non-dangerous conditions. Such conditions could include nearby heavy traffic, starting a vehicle in an attached garage, starting a fire or a nearby charcoal barbecue.

7. Replacement of Batteries / End-of-life

Low Batteries

Type of Alarm	LCD	LED	Sound Emitted
Digital LCD Screen	Lb	Red flashes every 60 seconds	Chirp every 60 seconds

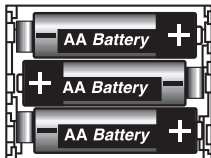

Slide alarm from back-plate.

Insert 3 x replacement 'AA' batteries

(noting polarity – see sketch)

Replace back-plate and test the alarm

RECOMMENDED BATTERIES:

Duracell MN1500, MX1500

Gold Peak 15A

Golden Power GLR6A

Energizer E91

Under normal operating conditions, the batteries will last a minimum of one year. These batteries can be purchased from your local retailer.

End-of-life - This alarm will chirp every 30 seconds with a red LED flash after at least 10 years operation to let you know it has reached its end of life. A replacement needs to be purchased.

8. What to do if Your Alarm Sounds!

Carbon Monoxide Alarm Procedure

⚠️ WARNING! Activation of the alarm indicates the presence of Carbon Monoxide (CO) at potentially hazardous or lethal levels of concentration in your environment

If alarm sounds (4 loud audible pulses followed by a pause for 5 seconds):

- 1) Immediately move to fresh air – outdoors or by an open door/window. Do a head count to check that all persons are accounted for. Do not re-enter the premises nor move away from the open door/window until the emergency services responders have arrived, the premises have been aired out, and your alarm remains in its normal condition.
 - 2) Call Emergency Services (Fire Brigade and/or Ambulance) on 000 (AUS) or 111 (NZ).
- Never restart the source of the CO problem until it has been corrected.
 - Never ignore the sound of the alarm! If the alarm is sounding, pressing the test/reset button will terminate the alarm.
 - If the CO condition that caused the alert in the first place continues, the alarm will reactivate.
 - If the unit alarms again within six minutes, it is sensing high levels of CO which can quickly become a dangerous situation.

9. Maintenance of Your Alarm





To keep your alarm in good working order:

- **Test every week**
- **Vacuum regularly to remove dust**
- **Keep away from solvents or detergents**
- **Avoid spraying air-freshener, hair-spray near the alarm**
- **Do not paint the alarm. If decorating or using adhesives close to the alarm, remove it temporarily**

THE FOLLOWING SUBSTANCES CAN AFFECT THE SENSOR AND CAUSE FALSE ALARMS:

Methane, Propane, Iso-butane, Iso-propanol, Ethylene, Benzene, Toluene, Ethyl acetate, Hydrogen Sulphide, Hydrogen, Sulphur Dioxide, alcohol based products, paints, thinners, solvents, adhesives, hair-sprays, aftershaves or perfumes and some cleaning agents.

10. Troubleshooting

Symptom	LCD Screen Display	Problem	Action Required
Single chirp every 60 seconds plus flashing red LED.		Low batteries	Change the batteries
Single chirp every 30 seconds plus flashing red LED		Alarm fault	Replace alarm (contact Chubb if still in warranty)
Red LED on and constant tone		Alarm malfunction	Replace alarm (contact Chubb if still in warranty)
Two chirps plus red LED flashes twice		End of Life of the alarm	Replace the alarm

11. Product Specifications

Power	3 x AA batteries (as supplied)
Sensor	Electrochemical CO Sensor
Accuracy	<p>Depending on the ambient conditions (temperature, atmospheric pressure and humidity) and the condition of the sensor, the CO level displayed may vary. The tolerance for the displayed CO level for readings between 30-999 PPM is +/- 30% when measured at the following atmospheric conditions:</p> <ul style="list-style-type: none">- 27°C +/- 5°C- Standard Atmospheric Pressure +/- 10%- 40% Relative Humidity +/- 3%
Temperature Range	Operating range: 0°C to 40°C
Humidity	Operating range: up to 90% relative humidity (RH)
Alarm Sound	At Least 85dB (A) at 1 metre @ 3.4 +/- 0.5 KHz pulsing alarm
Size and weight	Weight: 160g Dimensions: 118mm x 70mm x 40mm

12. Warnings and Important Notices

⚠ WARNING: THIS CARBON MONOXIDE ALARM IS NOT A SUBSTITUTE FOR INSTALLING AND MAINTAINING AN APPROPRIATE NUMBER OF SMOKE ALARMS IN YOUR HOME. THIS ALARM WILL NOT SENSE SMOKE, FIRE, OR ANY POISONOUS GAS OTHER THAN CARBON MONOXIDE. FOR THIS REASON YOU MUST INSTALL SMOKE ALARMS TO PROVIDE EARLY WARNING OF FIRE AND TO PROTECT YOU AND YOUR FAMILY FROM FIRE AND ITS RELATED HAZARDS.

⚠ WARNING: THIS PRODUCT IS INTENDED FOR USE IN ORDINARY INDOOR RESIDENTIAL AREAS. IT IS NOT DESIGNED TO MEASURE COMPLIANCE WITH COMMERCIAL AND INDUSTRIAL STANDARDS. THIS ALARM IS NOT SUITABLE FOR INSTALLATION IN HAZARDOUS LOCATIONS. INDIVIDUALS WITH MEDICAL PROBLEMS MAY CONSIDER USING WARNING DEVICES WHICH PROVIDE AUDIBLE AND VISUAL SIGNALS FOR CARBON MONOXIDE CONCENTRATIONS UNDER 30 PPM.

IMPORTANT: THIS CARBON MONOXIDE ALARM IS DESIGNED TO DETECT CARBON MONOXIDE FROM ANY SOURCE OF COMBUSTION INCLUDING IMPROPER OR MALFUNCTIONING APPLIANCES. THE INSTALLATION OF THIS DEVICE SHOULD NOT BE USED AS A SUBSTITUTE FOR PROPER INSTALLATION, USE AND MAINTENANCE OF FUEL BURNING APPLIANCES INCLUDING APPROPRIATE VENTILATION AND EXHAUST SYSTEMS

⚠ WARNING: THIS ALARM REQUIRES 3 "AA" RECOMMENDED BATTERIES (REFER TO PAGE 14) TO OPERATE.

⚠ WARNING: THIS UNIT IS NOT A SMOKE ALARM. IT WILL NOT SENSE SMOKE. FOR EARLY WARNING OF FIRE YOU MUST INSTALL SMOKE ALARMS.

IMPORTANT: IF ANY FAULT SIGNALS OCCUR, CONTACT THE MANUFACTURER OR SUPPLIER AND DO NOT CONTINUE USING THE ALARM

13. Warranty

TEN YEAR LIMITED WARRANTY

Warranty

Chubb Fire & Security Pty Ltd ("Chubb") warrants to the original consumer purchaser that each new CO alarm will be free from defects in materials and workmanship under normal use for a period of 10 years from the date of purchase. To the extent permitted by law, Chubb agrees to repair or replace (at our discretion) any defective product on presentation of the proof of purchase.

Australia warranty claims:

Where the goods are offered for sale in Australia, the benefits to the consumer given by this warranty are in addition to other rights and remedies of the consumer under the Australian Consumer Law and other applicable laws relating to the goods. Our goods come with guarantees that cannot be excluded under the Australian Consumer Law. You are entitled to a replacement or refund for a major failure and compensation for any other reasonably foreseeable loss or damage. You are also entitled to have the goods repaired or replaced if the goods fail to be of acceptable quality and the failure does not amount to a major failure.

New Zealand warranty claims:

Where the goods are offered for sale in New Zealand, the benefits to the consumer given by this warranty are in addition to other rights and remedies of the consumer under relevant New Zealand consumer protection laws and other applicable laws relating to the goods. Our goods come with guarantees that cannot be excluded under relevant New Zealand consumer protection laws. You are entitled to a replacement or refund for a major failure and compensation for any other reasonably foreseeable loss or damage. You are also entitled to have the goods repaired or replaced if the goods fail to be of acceptable quality and the failure does not amount to a major failure.

Exclusions

Subject to non-excludable laws, this warranty does not cover:

- normal wear and tear to the product or parts
- batteries or other consumables included with this product(excluding sealed non replaceable battery models)
- damage to the product caused by accidents, misuse, abuse, lack of reasonable care, tampering or repair by a person

not authorised by Chubb

- any product that has not been installed, operated or maintained in accordance with the user guide or operating instructions provided with the product
- any damage caused by improper power input or improper cable connection
- any indirect or special loss or damage of any kind

To make a claim

If a defect in the product appears within the time frame stated, you are entitled to submit a warranty claim by returning your product to the address shown below. **Please contact Chubb on the telephone numbers provided below, Monday to Friday during 9.00AM - 5.00PM.** When returning the product, please ensure it is properly packaged so that no damage occurs during transit. Any postage and packaging expenses required to return the product to Chubb will be at your cost.

Please provide the original or a copy of the proof of purchase. Also, please make sure you have included an explanation of the problem.

If Chubb elects to repair the product, please note that goods presented for repair may be replaced by refurbished goods of the same type rather than being repaired. Refurbished parts may be used to repair the goods.

This warranty is provided by:

Chubb Fire & Security Pty Ltd

ABN 47 000 067 541

A UTC Climate, Controls & Security Company

149-155 Milton Street, Ashfield NSW 2131 Australia

Telephone: 1800 654 435

Website: www.quell.com.au

Chubb New Zealand Limited

A UTC Climate, Controls & Security Company

3 Fisher Crescent, Mt Wellington, Auckland, New Zealand

Telephone: 09 270 7288

Website: www.quell.co.nz

14. Environmental Protection

Waste electrical products should not be disposed of with household waste. Please recycle where facilities exist. Check with Local Authority or retailer for recycling advice



Useful Contact Information

Quell Website	Australia: www.quell.com.au New Zealand: www.quell.co.nz
Address	Chubb Fire & Security Pty Ltd ABN 47 000 067 541 A UTC Climate, Controls & Security Company 149-155 Milton Street, Ashfield NSW 2131 Australia
Telephone	1800 654 435
Address	Chubb New Zealand Limited A UTC Climate, Controls & Security Company 3 Fisher Crescent, Mt Wellington, Auckland, New Zealand
Telephone	09 270 7288