

MAJESTIC®

LED TV

GTV2400DA

OWNER'S MANUAL

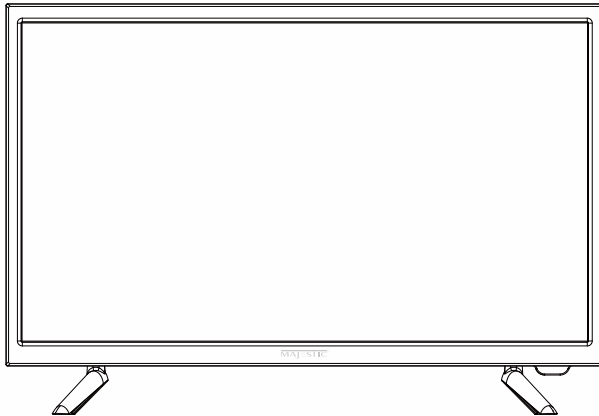

Please read this manual carefully before TV operation.
Retain it for future reference.

Important Safety Instructions and Maintenance

Important Safety Instructions

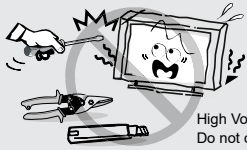

High Voltage
Do not open

CAUTION

Risk of electronic shock, do not open. Do not attempt to service this product yourself as opening or removing covers may expose you to dangerous voltage or other hazards. Refer all servicing to qualified service personnel.

To reduce the risk of fire or electric shock, do not expose this product to rain or moisture. The apparatus shall not be exposed to dripping or splashing and no objects filled with liquids, such as vases, shall be placed on the apparatus.



The screen and cabinet get warm when the TV is in use. This is not a malfunction. In case of smoke, strange noise or strange smell from the unit:

- Turn off the power switch immediately;
- Disconnect the power plug from the power outlet;
- Contact your dealer or service centre. Never attempt to make repairs yourself because this could be dangerous.

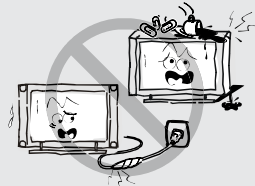

If the following problems occur:

Turn off the TV set and unplug the AC power cord immediately if any of the following problems occur. Ask your dealer or service centre to have it checked by qualified service personnel.

When:

- AC power cord is damaged.
- Poor fitting of AC power outlet.
- TV set is damaged by being dropped, hit or having something thrown at it.
- Any liquid or solid object falls through openings in the cabinet.

Never push objects of any kind into the set through the cabinet slots as they may touch dangerous voltage points or short-circuit parts that could result in a fire or electric shock. Never spill liquid of any kind on the set. Use special caution in households where children are present. The apparatus is not suitable for children under 3-year to operate.



Do not overload wall outlets, extension cords or adaptors beyond their capacity, this can result in fire or electrical shock. Power-supply cords should be routed so that they are not likely to be walked on or pinched by items placed upon or against them, paying particular attention to cords at plug end, adaptors and the point where they exit from the appliance. The mains plug is used as the disconnect device. It shall remain readily accessible and should not be obstructed during intended use. Make sure to plug the power cord in until it is firmly inserted. When removing the power cord, make sure to hold the power plug when pulling the plug from the outlet, do not pull the plug out by the wire. NEVER touch the plug or power cord with wet hands. To disconnect the apparatus from the mains power, the plug must be pulled out from the mains socket, therefore make sure the mains plug is always easily accessible.

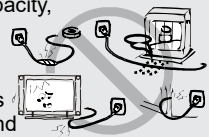

Do not push or scratch the front filter, or place any objects on top of the TV set. The image may be uneven or the screen may be damaged.

To avoid the fire, no naked flame source, such as lighted candles, should be placed on the apparatus.



Important Safety Instructions and Maintenance

Important Safety Instructions

An outside antenna system should not be located in the vicinity of overhead power lines or other electric light or power circuits, or where it can fall into such power lines or circuits. When installing an outside antenna system, extreme care should be taken to keep from touching such power lines or circuits as contact with them might be fatal. Ensuring the television is not overhanging the edge of the supporting furniture.

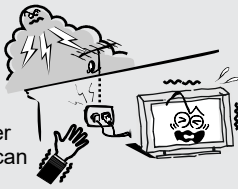

When not in use

If you will not be using the TV set for several days, the TV set should be disconnected from the AC mains for environmental and safety reasons. As the TV set is not disconnected from the AC power when the TV is turned off at the standby switch, pull the plug from the AC power outlet to disconnect the TV completely. However, some TV sets may have features that require the TV set to be left in standby to function correctly. In the case of lightning, unplug the TV set from the outlet immediately. Never touch the antenna wire during lightning.



Do not pull the plug out by the wire; Never touch the plug with wet hands.

Excessive volume from earphones and headphones can cause hearing loss.



Installation



The ventilation should not be impeded by covering the ventilation opening with items, such as newspapers, tablecloths, curtains, etc. At least 10 cm space should be left around the apparatus for sufficient ventilation.

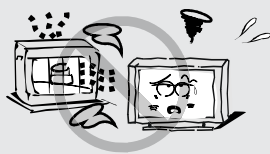

The product should be situated away from heat sources such as radiators, heat registers, stoves, or other products (including amplifiers) that produce heat. Place the apparatus in such a position that the screen is not exposed to direct sunlight. It is best to have soft indirect lighting while watching and avoid completely dark environments and reflection from the screen as these may cause eye fatigue. Keep the TV set away from any equipment emitting electromagnetic radiation.

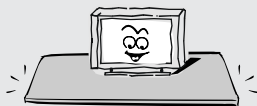

Do not place the set on an unstable cart, stand, table or shelf. The set may fall, causing serious personal injury as well as damage to the product. Use only with the cart, stand, tripod, bracket, or table specified by the manufacturer, or sold with the apparatus. An appliance and cart combination should be moved with care. Quick stops, excessive force, and uneven surfaces may cause the appliance and cart combination to overturn.



Do not place this apparatus near water, for example, near a bath tub, wash bowl, kitchen sink, or laundry tub; in a wet basement; or a swimming pool; and the like;

Important Safety Instructions and Maintenance

Installation



When the TV being moved in from cold place, it needs some right time for dew inside unit evaporating fully before turn on the unit;

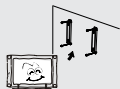

To prevent injury, this apparatus must be securely attached to the floor/wall in accordance with the installation instructions.

LED Screen

Although the LED screen is made with high precision technology and 99.99% or more of the pixels are effective, black dots may appear or bright points of light (red, blue or green) may appear constantly on the LED screen. This is a structural property of the LED screen and is not a malfunction. If the surface of the LED panel cracks, do not touch it until you have unplugged the AC power cord. Otherwise electric shock may result. Do not throw anything at the TV set. The LED panel may break from the impact and cause serious injury.

Precautions When Displaying a Still Image

A still image may cause permanent damage to the TV screen.

Do not display still images and partially still images on the LED panel for more than 2 hours as it can cause screen image retention. This image retention is also known as "screen burn". To avoid such image retention, reduce the degree of brightness and contrast of the screen when displaying a still image.

Watching the LED TV in 4:3 format for a long period of time may leave traces of borders displayed on the left, right and centre of the screen caused by the difference of light emission on the screen. Playing a DVD or a game console may cause a similar effect to the screen. Damages caused by the above effect are not covered by the Warranty.

Displaying still images from Video games and PC for longer than a certain period of time may produce partial after-images. To prevent this effect, reduce the 'brightness' and 'contrast' when displaying still images.

Cleaning

Cleaning and handling the screen surface and cabinet. Disconnect the unit from the AC outlet before cleaning. To remove dust, wipe gently with a soft, lint free cloth. If required use a slightly damp cloth.



MAINS PLUG

Wipe the mains plug with a dry cloth at regular intervals. Moisture and dust may lead to fire or electrical shock.



Use care not to subject the TV's surfaces to detergent. (A liquid inside the TV could lead to product failure, fire or electrical shock.) Use care not to subject surfaces to bug repellent, solvent, thinner, or other volatile substances as this may deteriorate the surface and finish of the cabinet.

Attention should be drawn to the environmental aspects of battery disposal;

This equipment is a Class II or double insulated electrical appliance. It has been designed in such a way that it does not require a safety connection to electrical earth.



Important Information

If a television is not positioned in a sufficiently stable location, it can be potentially hazardous due to falling. Many injuries, particularly to children, can be avoided by taking simple precautions such as:

- Using cabinets or stands recommended by the manufacturer of the television.
- Only using furniture that can safely support the television.
- Ensuring the television is not overhanging the edge of the supporting furniture.
- Not placing the television on tall furniture (for example, cupboards or bookcases) without anchoring both the furniture and the television to a suitable support.
- Not standing the televisions on cloth or other materials placed between the television and supporting furniture.
- Educating children about the dangers of climbing on furniture to reach the television or its controls.
- Keep small accessories out of reach of children so they are not mistakenly swallowed.

Table of Contents

Accessories -----	5
Introduction -----	6
Features-----	6
Specifications-----	7
Stand and wall-mounting instructions (optional) -----	8
General Description -----	9
Overview of front panel-----	9
Overview of back panel-----	10
Overview of remote control-----	11
Installing Batteries in the Remote Control-----	12
TV Operation -----	14
Read before using Apps-----	21
Troubleshooting -----	22

Accessories

Please make sure the following items are included with your LED TV. If any items are missing, contact your dealer.

- > LED television
- > Remote control with 2X AAA batteries
- > Quick Start Guide
- > VESA mounting screws(BM4*8 4pcs)
- > Power adaptor (12V,4A)
- > Biped base
- > Base stand and screws
- > 12V Cigarette adaptor

Introduction

Features

- TV adopts 24" TFT LED display screen
- Zero X radiation complies to green environment protection requirement
- Connect to computer directly to realize TV/monitor combo.
- USB 2.0
- 16:9 wide screen
- Auto tuning and fine tuning
- HDMI input
- Programmable sleep timer
- No-signal automatic power off
- DVD Player Built In

Basic Functions

Input terminals used for external equipment connection

- 2 x RF input
- 2 x USB inputs
- 2 x HDMI inputs
- 1 x AV OUT
- 1 x OPTICAL
- 1 x Headphone output

Introduction

Specifications

Model	GTV2400DA	
Display size	24" Diagonal (max.)	
LED panel resolution	1920x1080	
Speaker output power	≤5Wx2	
Power supply	Power adaptor (12V,4A)	
TV receive system	Digital: DVB-C/T/T2/S/S2 Analog: PAL DK/BG/I SECAM DK/BG	
Video in	PAL/NTSC	
Dimensions (LxWxH)	TV with stand	553x374x154mm
	TV without stand	553x333x51mm
Weight (Net weight)	TV with stand	3.6kg
	TV without stand	3.5kg
Work temperature	0°C-40°C	

NOTES:

- Design and specifications are subject to change without notice.
- Weight and Dimension shown are approximate.



The terms HDMI and HDMI High-Definition Multimedia Interface, and the HDMI Logo are trademarks or registered trademarks of HDMI Licensing Administrator, Inc. in the United States and other countries.

Stand and wall- mounting instructions (optional)

How to assemble the stand

If you need to remove or assemble the stand please read the following instructions.

-Before attaching/detaching the stand, make sure to turn off the TV.

-Before performing work, spread cushioning over the base area to lay the LED TV on. This will prevent it from being damaged.

Assembling instruction:

Put the television on the table, fix the stands with two screws given in the carton.

Step1: Fasten the base assembly with 2 screws given in the carton.

Step2: Insert the assembled base into the hole, take out 2 screws provided with TV set and tighten them into screw holes.

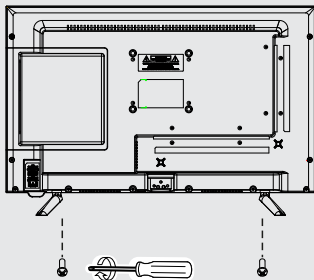

- To disconnect the stand from the TV, perform the above steps in reverse order.

Note:

The product and illustrations in this user's manual is only for explanation purposes and may vary depending on model.

General Description

Overview of front panel

The buttons on the lower-right panel control your TV's basic features, including the on-screen menu. To use the more advanced features, you must use the remote control.

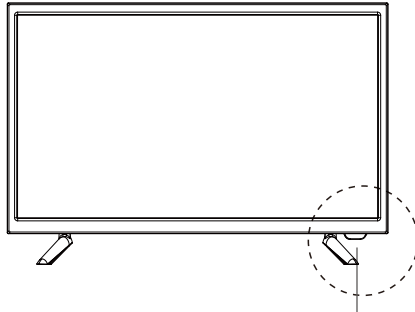

Remote Control Sensor
Power Indicator

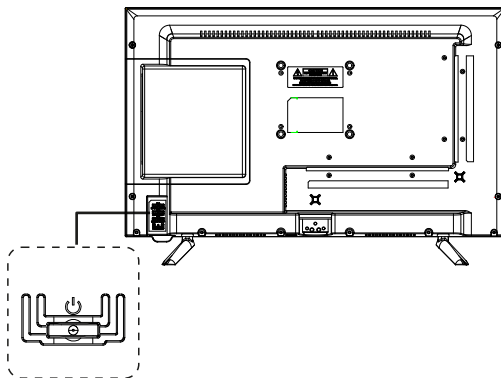

Power on/Power off button

General Description

Overview of back panel

You can connect the TV with video devices such as DVD/VCD player, VCR and video camera to enjoy the high quality picture.

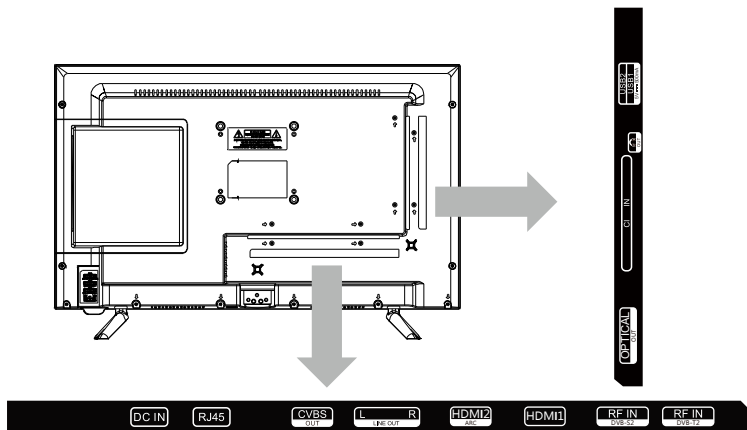

Note:

The product and illustrations in this user's manual is only for explanation purposes and may vary depending on model.

General Description

Overview of Remote Control



Loading batteries:















- 1) Remove the lid of the battery compartment.
- 2) Insert 2 size AAA batteries with polarities as indicated inside the compartment.
- 3) Replace the lid.

Note:

- 1) A loading of batteries should be last one year under normal use.
- 2) If you don't intend to use the remote control for a long period of time, remove batteries to avoid damage due to leakage.
- 3) Do not mix old and new batteries or different types.
- 4) Do not throw batteries into fire or water.
- 5) The batteries (battery pack or batteries installed) should not be exposed to excessive heat such as sunshine, fire or the like.

General Description

Overview of Remote Control

- 1. POWER:** Turn the TV on and off.
- 2. **: Press to select the input source.
- 3. +/-:** Press these buttons to adjust the volume.
- 4. **: Press these buttons to change channel upward or downward.
- 5. **: Press this button to cut off the sound of the TV set temporarily, press again to resume.
- 6. Google Assistant:** Press the google assistant for starting the text search.
- 7. **: Quick Settings.
- 8. GUIDIE:** Select electronic program guide, in DTV mode, it will display all the information of program in a week when pressing this button.
- 9. Arrow buttons **: Use to select on-screen menu items and change menu values.
- 10. **: Confirms selection.
- 11. BACK:** Return to the previous menu.
- 12. EXIT:** Exit the menu.
- 13. **: Smart TV - return to home screen.
- 14. TEXT:** Open the TEXT.
- 15. SUBT:** Open or close subtitle.
- 16. AUDIO:** Press to select mono, nicam, stereo for ATV channel, audio language for DTV channel
- 17. NETFLIX:** If network connects, press this key to view NETFLIX directly.
- 18. YouTube:** If network connects, press this key to view YouTube directly.
- 19. Google Play:** If network connects, press this key to view Google Play store directly.
- 20. Prime Video:** If network connects, press this key to view Prime Video directly.
- 21. DVD:** When input is in DVD mode, press the DVD key to open the DVD. When the DVD is working or not in use, press this key to close the DVD to reduce power consumption.
- 22. **: Eject/insert disc.
- 23. **: The functions of up selection and previous track in DVD.
- 24. **: The functions of left selection and fast back in DVD.
- 25. **: The functions of right selection and fast forward in DVD.
- 26. **: The functions of confirm and play/pause in DVD.
- 27. **: The functions of down selection and next track in DVD.
- 28. MENU:** go back to catalogue of DVD.
- 29. **: The function to stop DVD play.
- 30. 0-9:** The digital input in DVD.
- 31. SETUP:** The function of setting in DVD.
- 32. GOTO:** The function of jump to the specified label.

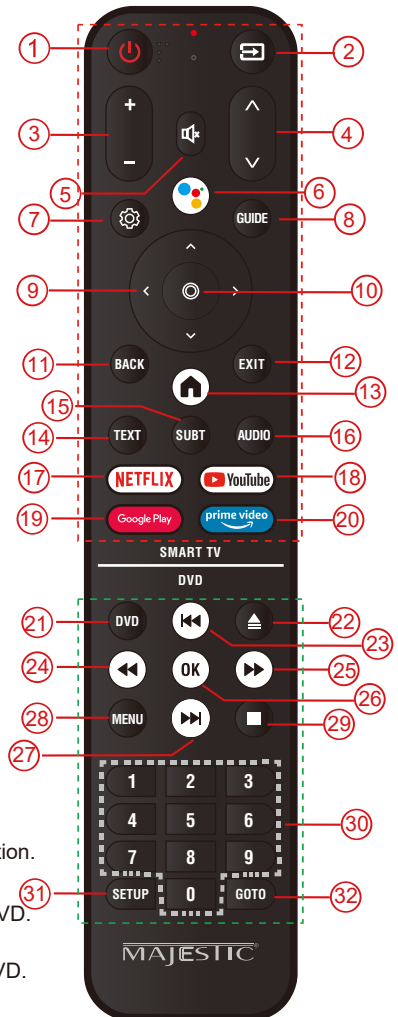

General Description

Installing Batteries in the Remote Control

Installing Batteries

- 1** Open the battery compartment cover on the back side.

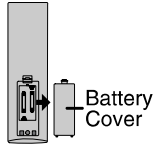

- 2** Insert two 1.5V AAA size batteries in correct polarity. Don't mix old or used batteries with new ones.

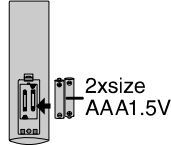

- 3** Closed the cover.

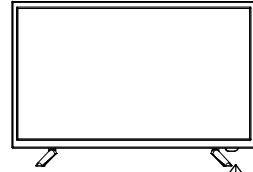
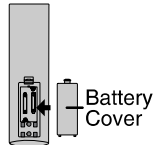

30° 30°



- † Point the remote towards the remote control sensor of the TV and use it within 8 meters.
- † Put the used batteries into the recycling bin since they can negatively affect the environment.

NOTES:

- One loading of batteries will last for 1 year under normal use.
- If you do not intend to use the remote controller for a long period of time, remove them to avoid damage due to leakage.
- Do not use old and new batteries together.
- The batteries (battery pack or batteries installed) shall not be exposed to excessive heat such as sunshine, fire or the like.

TV Operation

INITIAL SETUP

The first time you turn on your TV, the setup wizard will guide you through setting up basic settings. Please according to the Text Tip to First Time Setup.

This function is used for the remote control pair code. After the code is successful, you can use the Bluetooth remote control to operate the TV.

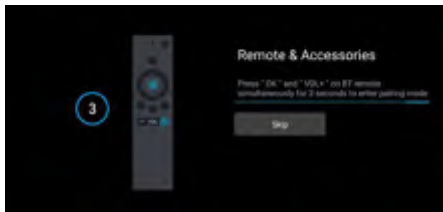

Press ▲/▼ to select the system language and press OK to confirm the language.

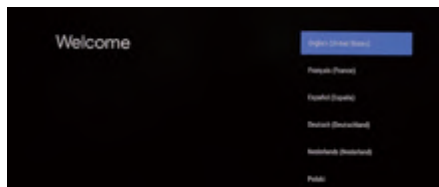

Connect your Android phone to your TV, select "Continue" to continue the connection, and choose "Skip" to skip this step.

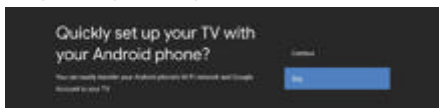

Press ▲/▼ to select the wifi to connect, press OK and enter the password to confirm the connection is successful.

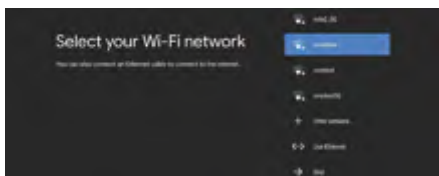

By accepting the Google Terms of Service to improve the product experience, select "Accept" to accept this condition.

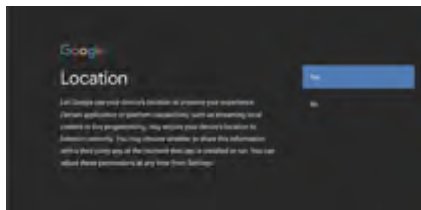
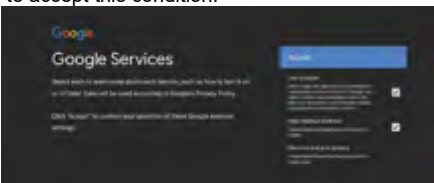

Agree to Google to get the location information of your device to get more features, choose "YES" to accept.

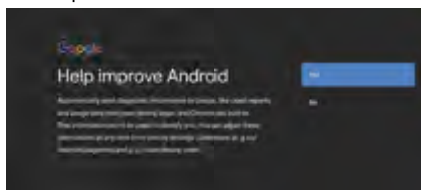

By agreeing to automatically send diagnostic information to Google to improve discriminative power, choose "YES" to accept.



1. Your device is powered by Android TV and press the ► button to select the browsing feature.
2. You can get more apps from Google Play and press the ► button to go to the next screen.
3. Transfer photos and other content to the TV via the built-in chromecast, press OK to complete the browsing.

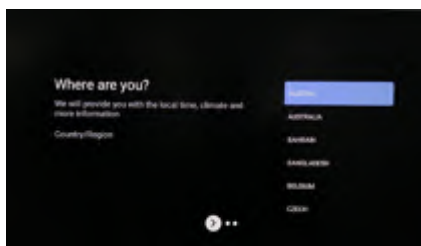

Press ▲/▼ to select the country of your device and press OK to confirm.



TV Operation

HOME SCREEN

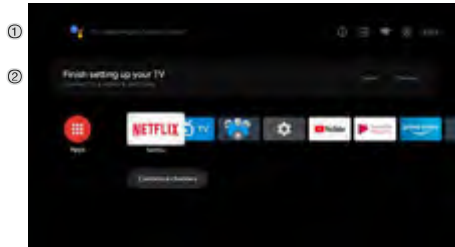
After completing the wizard Settings, you can watch TV and go to the home screen.



- ① Open Google Assistant or start a text search.
- ② Among the applications installed on the TV, the icons for the favourite applications are shown inside here. (Favourite applications can be added/ deleted/changed its order by users.)

-  Inputs: Icon to select an input source.
-  Settings: Various settings can be configured here. For details on the settings, see the next explanation.

INPUT SOURCE

1. In the HOME interface, press ▲/▼/◀/▶ to select the "Inputs" icon, press OK to open the input source list, then press up to highlight an input and press OK to switch.

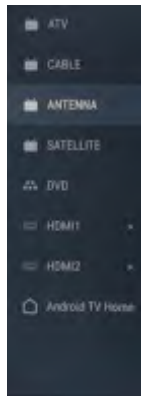
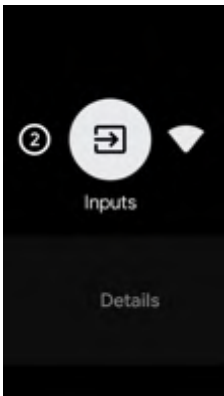

2. Under live TV, press the SOURCE button to display the list of input sources. You can select the desired source.

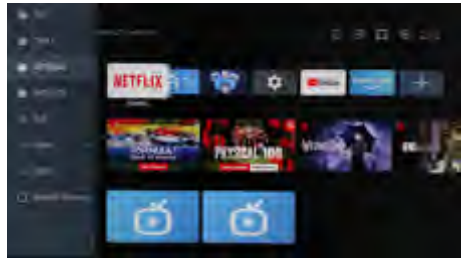

NAVIGATING THE ON-SCREEN MENU

1. In the HOME interface, press the key to select the icon of the circular settings menu, press OK to confirm.

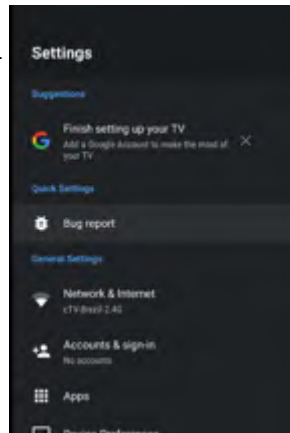

2. Press ▲/▼ button to select what you want set.
3. Press OK to enter setting.

TV Operation

Network

1. Press ▲/▼ button to select what you want set.
2. press **OK** button to adjust.
3. After finishing your adjustment, press **OK** button to save and return to the previous menu.

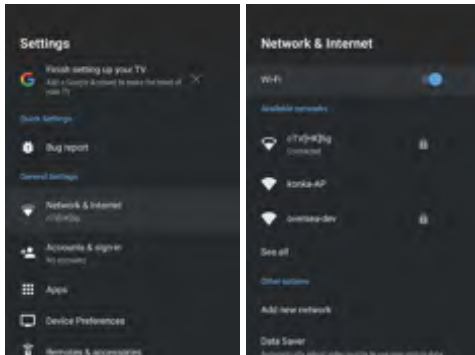

DEVICE PREFERENCES ABOUT

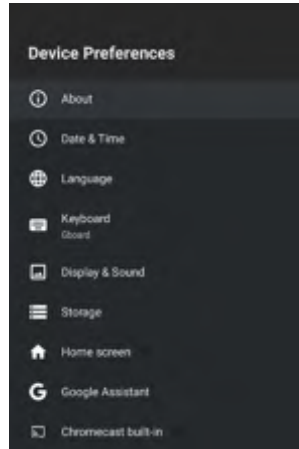

APPS

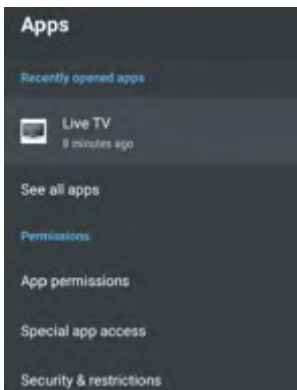

In this menu, you can set the APP permissions, and read the app lists.

1. Press ▲/▼ button to select what you want set.
2. Press **OK** button to adjust.
3. After finishing your adjustment, press **BACK** button to return to the previous menu.

In this menu, you can read the information and settings of TV.

1. Press ▲/▼ button to select what you want set.
2. Press **OK** button to adjust.
3. After finishing your adjustment, press **BACK** button to return to the previous menu.

TV Operation

DATE & TIME

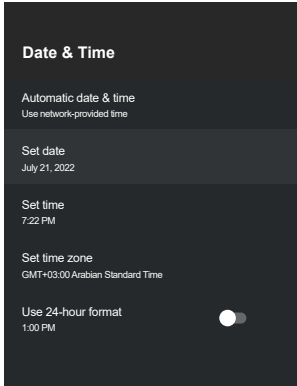

Automatic date & time- Press ▲/▼ button to select the option then press **OK** button to enter the sub-menu. (Optional: Use network-provided time, Off)

- Manually adjusting date & time settings will automaticall change the **Automatic date & time** to **OFF**.

Set date- Press ▲/▼ button to select the option then press **OK** button to enter the sub-menu.

Set time- Press ▲/▼ button to select the option then press **OK** button to enter the sub-menu.

Set time zone- Press ▲/▼ button to select the option then press **OK** button to enter the sub-menu.

Use 24-hour format- Press ▲/▼ button to select the option then press **OK** button to choose ON/OFF.

LANGUAGE

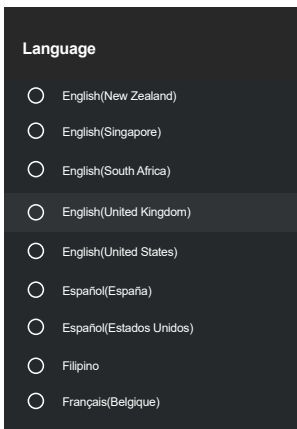

Language- Press ▲/▼ button to select the option then press **OK** button to enter the select language.

KEYBOARD

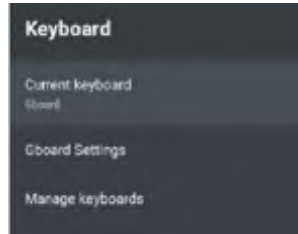

Current keyboard- Press ▲/▼ button to select the option then press **OK** button to enter the sub-menu.

Gboard Settings- Press ▲/▼ button to select the option then press **OK** button to enter the sub-menu.

Manage keyboards- Press ▲/▼ button to select the option then press **OK** button to enter the sub-menu.

ENERGY SAVER

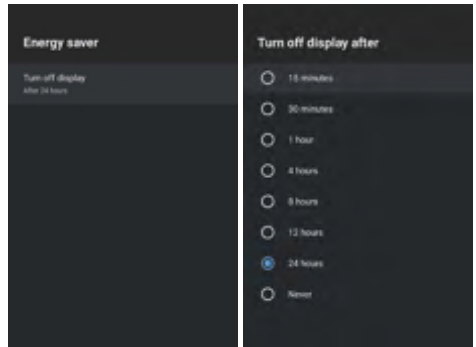

Turn off Display- Press ▲/▼ button to select the option then press **OK** button to enter the sub-menu. (Optional: 15 minutes, 30 minutes,24 hours, Never.)

TV Operation

SOUND

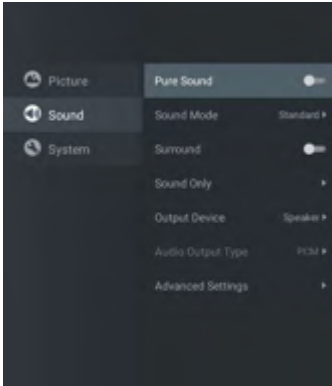

Press MENU key to the main menu, and select Sound.

Sound Mode- Press **OK** to enter the sub-menu, press button to select option and press **OK** to select the option.

Pure Sound- Press **▲/▼** button to select the option then press **OK** button to choose ON/OFF.

Surround- Press **▲/▼** button to select the option then press **OK** button to choose ON/OFF.

Sound Only- Press **OK** to enter the sub-menu, press button to select option.

Output Device- Press **▲/▼** to enter the sub-menu.

Audio Output Type- Press **▲/▼** to enter the sub-menu.

Advanced Settings- Press **▲/▼** to enter the sub-menu.

PICTURE

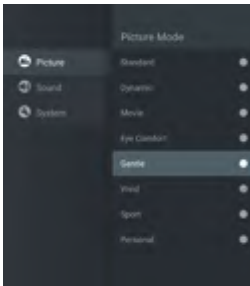

Picture Mode- Press **▲/▼** button to select the option button to enter the sub-menu.(Optional: Standard, Dynamic, Movie, Eye Comfort, Gentle, Vivid, Sport, Personal).

Brightness/Color Saturation/Hue/Contrast/Gamma/Black Level

Sharpness- Press **▲/▼** button to select the option.

Press **◀** to decrease the parameter. Press **▶** to increase the parameter.

Gamma- Press **▲/▼** button to select the option.

Press **◀** to decrease the parameter.

Press **▶** to increase the parameter.

STORAGE

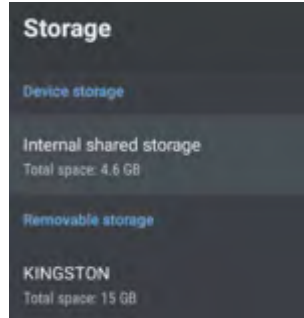

Internal shared storage- Press **▲/▼** button to select the option then press **OK** button to enter the sub-menu.

Removable Storage- Press **▲/▼** button to select the option then press **OK** button to enter the sub-menu.(Note: Show external devices if available)

HOME SCREEN

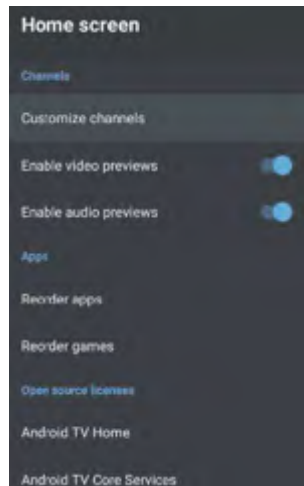

In this menu, you can set channels, apps, open source licenses.

1. Press **▲/▼** button to select what you want set.
2. Press **OK** button to adjust.
3. After finishing your adjustment, press **BACK** button return to the previous menu.

TV Operation

GOOGLE

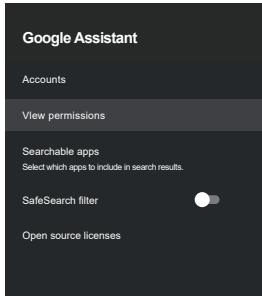

In this menu, you can set searchable apps, safe search filter, block offensive words, open source licenses.

1. Press ▲/▼ button to select what you want set.
2. Press **OK** button to adjust.
3. After finishing your adjustment, press **BACK** button return to the previous menu.

CHROMECAST BUILT-IN

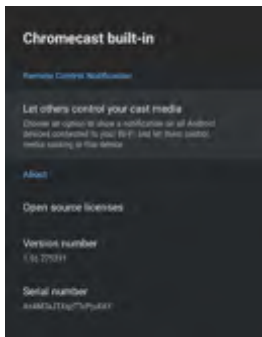

In this menu, you can read the information and settings of Chromecast.

1. Press ▲/▼ button to select what you want set.
2. Press **OK** button to adjust.
3. After finishing your adjustment, press **BACK** button return to the previous menu.

SCREEN SAVER

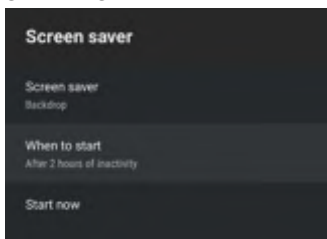

Screen saver- Press ▲/▼ button to select the option then press **OK** button to enter the sub-menu. (Optional: Turn screen off, Backdrop, Colors)

When to Start- Press ▲/▼ button to select the option then press **OK** button to enter the sub-menu. (Optional: 5 minutes, 15 minutes, 30 minutes, 1 hour, 2 hours.)

Start now- Press ▲/▼ button to select the option then press **OK** button to enter screen saver.

LOCATION

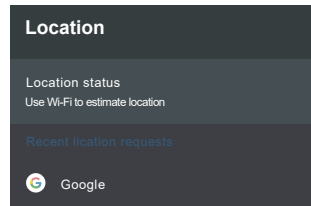

Location status- Press ▲/▼ button to select the option then press **OK** button to enter the sub-menu. (Optional: Use Wi-Fi to estimate location, Off)

USAGE & DIAGNOSTICS

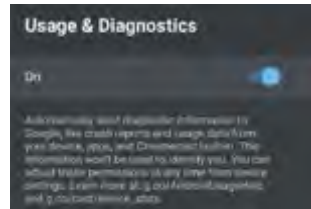

Usage & diagnostics- Press ▲/▼ button to select the option then press **OK** button to choose ON/OFF.

ACCESSIBILITY

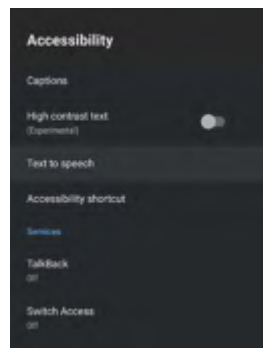

Captions- Press ▲/▼ button to select the option then press **OK** button to enter the sub-menu.

TV Operation

High contrast text- Press ▲/▼ button to select the option then press **OK** button to choose ON/OFF.
Text to speech- Press ▲/▼ button to select the option then press **OK** button to enter the sub-menu.
Accessibility shortcut- Press ▲/▼ button to select the option then press **OK** button to choose ON/OFF.
TalkBack- Press ▲/▼ button to select the option then press **OK** button to enter the sub-menu.
Switch Access- Press ▲/▼ button to select the option then press **OK** button to enter the sub-menu.

RESTART

Press **OK** button to enter the sub-menu.
Restart the TV.

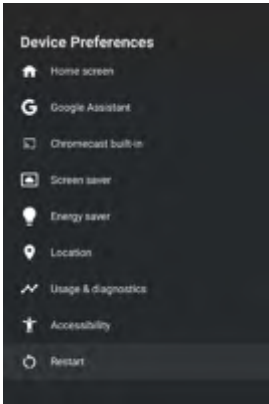

REMOTES & ACCESSORIES

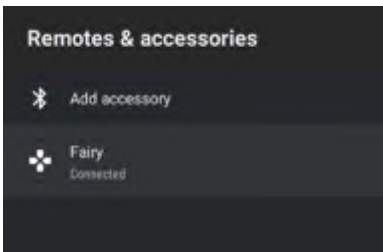
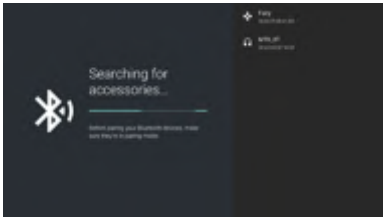

Note: It is only available to the remote control with Bluetooth.

In this menu, you can pair Bluetooth devices.

1. Press "**OK**" and "**Volume+**" buttons for about 5 seconds.
2. When the LED starts to flash, release it. The remote controller will send the pairing signal to the TV and display the information of the remote control on the right side of the screen.
3. Press the **OK** button to display the pairing. If the paired is displayed, the connection is successful.
4. Press **BACK** button return to the previous menu.

ADD AND USE OF MEDIA PLAYER

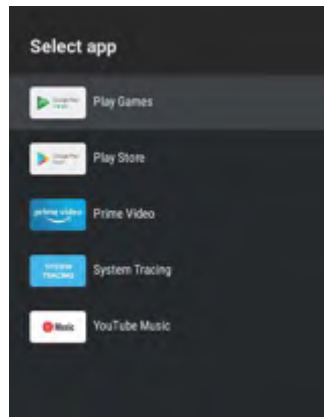

1. In the HOME interface, select the + icon in the APP column to add the application, and click **OK**. Press up and down to select the Media Player application, and click **OK** to add it to the HOME interface.

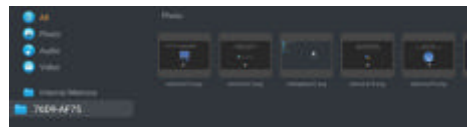

2. Focus on the corresponding USB driver and press **OK** to display video, photo, audio files. Press navigation button to select the file.

NOTE

The menu/function may be different depending on when you purchased the TV.

Read Before Using Apps

(*Terms & Conditions apply)

- Due to the product characteristics featured on the Apps store, as well as limitations in available content, certain featured applications, and services may not be available on all devices or in all territories. Some Apps featured may also require additional peripheral device or membership fees. Services and content availability are subject to change without prior notice.
- Manufacture takes no legal responsibility whatsoever for any interruption of App services caused by the service provider for any reason.
- An unstable Internet connection may cause delays or interruptions. In addition, applications may terminate automatically depending on the network environment.
- Applications services and updates may become unavailable.
- Application content is subject to change by the services provider without prior notice.
- Specific services may differ with the version of the application installed on the TV.
- An application's functionality may change in future version of the application.
- Depending on the third party service provider's policies, certain applications may not support multitasking.
- The response to remote commands and the resulting on-screen display may be delayed while a webpage is loading.
- The copy and paste operations are not supported.
- The web browsing speed will differs with the network environment.
- Depending on the types of video/audio codecs supported, it might not be possible to play certain video and audio files while playing content.
- Apps store have certain limitation, it consist many inbuilt apps for various needs of user but user doesn't have facility to add other apps from any other media.

Troubleshooting

If you have any problem, check the counter measures for each symptom listed below. The following symptoms may have been caused by inappropriate adjustment rather than actual malfunction of the unit. If the trouble persists, contact the Customer Care Centre, see back page for contact details.

Symptoms	Possible solutions
No power	Please check the power cord plugged in and that the power outlet works. Unplug the power cord and plug it in after 60 seconds and restart the TV.
No picture	Please check antenna connection. Station may be experiencing problems, please tune to another station. Please adjust the settings of contrast and brightness.
Good picture but no sound	Please increase the volume. Please check TV is under mute mode, press MUTE button on the remote control. Please check sound settings If external devices are being used, check their volumes are not set too low or turned off. If using AVI or Component inputs, please make sure cables are connected properly and not loose. If using DVI to HDMI cable, a separate audio cable is required. Make sure a headphone jack is not connected.
Good sound but abnormal color or no picture	Please check antenna connection and antenna condition. If using Component input, please check Component connections, incorrect or loose connections may cause colour problems or cause the screen to be blank.
No response to remote control	Batteries of remote control may have exhausted, if necessary, please change the batteries. Clean the remote control lens. The distance between LED TV and remote control should be within 8m, within recommended operating angle and path is free of obstructions.
Colored dots may be present on the screen	Although the LED screen is made with high-precision technology and 99.99% or more of the pixels are effective, black dots may appear or bright points of light (red, blue, or green) may appear constantly on the LED screen. This is a structural property of the LED screen and not a malfunction.
Picture is breaking up	Keep the TV away from noisy electrical sources such as cars, hair dryers, welders, and all optional equipment. Electrical atmospheric interference such as local or distant lightning storms may cause picture to break up. When installing optional equipment, leave some space between the optional equipment and the TV. Check the antenna and connection. Keep the antenna away from any power or input/output cables.

Troubleshooting

After Auto Tuning only some channels are available	Check your area is covered by Digital Video Broadcasts. Try re-tuning or manually tuning missing channels. Check that you are using the correct antenna type.
Channel cannot be selected	Check if the channel has been blocked in the main menu settings.
USB not playing	Please check connecting USB cable and power supply is connected. Hard drive has not been formatted. Please make sure USB disk is compatible and the multimedia data formats are supported. Only support FAT32 format for the USB disk.
Picture is distorted, macroblock, small block, dots, pixelization, etc	Compression of video contents may cause distortion especially on fast moving pictures such as sports and action movies.
Noise from speaker	Check cable connections, make sure a video cable is not connected to an audio input. Low signal level may cause sound distortion.
TV turns off automatically	Check if the Off Timer is set to On in the Setup menu. Sleep Timer may have been enabled. If there is no signal for about 10 minutes from an input, the TV will turn off.
TV turns on automatically	Check if the On Timer is set to On in the Setup menu.
Picture is not shown in full screen	Black bars on each side will be shown on HD channels when displaying SD (4:3) contents. Black bars on Top & Bottom will be shown on movies that have aspect ratios different from your TV. Adjust picture size option on your external device or TV to full screen.

WARNING

Never place a television set in an unstable location. A television set may fall, causing serious personal injury or death. Many injuries, particularly to children, can be avoided by taking simple precautions such as:

- Using cabinets or stands recommended by the manufacturer of the television set.
- Only using furniture that can safely support the television set.
- Ensuring the television set is not overhanging the edge of the supporting furniture.
- Not placing the television set on tall furniture (for example, cupboards or bookcases) without anchoring both the furniture and the television set to a suitable support.
- Not placing the television set on cloth or other materials that may be located between the television set and supporting furniture.
- Educating children about the dangers of climbing on furniture to reach the television set or its controls

If your existing television set is being retained and relocated, the same considerations as above should be applied.

The plug or appliance coupler is used as the disconnect device, the disconnect device shall remain readily operable.

MAJESTIC®